

SMD Power Inductor

CD3012MB/DS



特性

- Ferrite core construction
- Low profile Resin-shielded
- L × W × H: 3.2 × 3.2 × 1.2mm Max.
- Product weight: 0.038g(Ref.)
- Moisture Sensitivity Level: 1

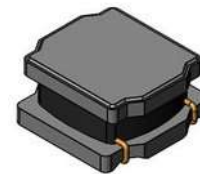

環境データ

- Operating temperature range: -40°C ~ +105°C (including coil's self temperature rise)
- Storage temperature range: -40°C ~ +105°C

梱包

- Carrier tape and reel packaging
- 2000pcs per reel

用途

- DC/DC converter for CPU in notebook PC, smart phone, LCD displays, HDDs, DVDs, SSDs, DVCs, DSCs, PDAs etc.

外形寸法 - [mm]

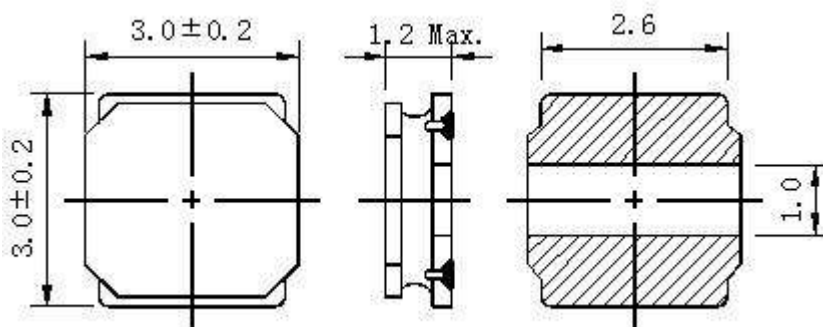

推奨ランド寸法 - [mm]

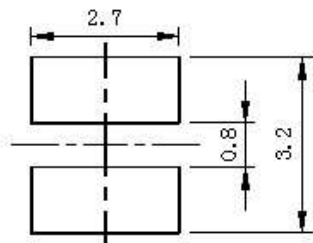

結線図

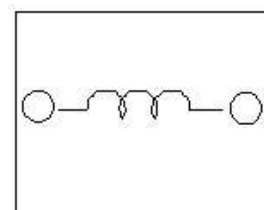

SMD Power Inductor

CD3012MB/DS



新しい注目の製品

電気的特性

品名	インダクタンス範囲 (μ H) ※1	D.C.R. ($m\Omega$) 20°C Max.(Typ.)	直流重畳電流 (A) Max.(Typ.) ※2	温度上昇電流 (A) Max.(Typ.) ※3
CD3012MBDS-1R0NC	1.00	65.00 (54.00)	1.90 (2.20)	(2.10)
CD3012MBDS-1R5NC	1.50	88.00 (73.00)	1.60 (1.80)	(1.80)
CD3012MBDS-2R2PC	2.20	137 (114)	1.40 (1.70)	(1.40)
CD3012MBDS-3R3PC	3.30	245 (204)	1.30 (1.50)	(1.00)
CD3012MBDS-4R7PC	4.70	293 (244)	1.00 (1.10)	(0.94)
CD3012MBDS-6R8PC	6.80	374 (312)	0.80 (0.95)	(0.80)
CD3012MBDS-100MC	10.00	563 (469)	0.68 (0.80)	(0.67)

※1 Measuring frequency Inductance at 100kHz 1V.

※2 Saturation current: This indicates the value of D.C. current when the inductance becomes 30% lower than its initial value.

※3 Temperature rise current: The actual value of D.C. current when the temperature of coil becomes $\Delta T=40^\circ\text{C}$ ($T_a=25^\circ\text{C}$).

はんだリフロー条件

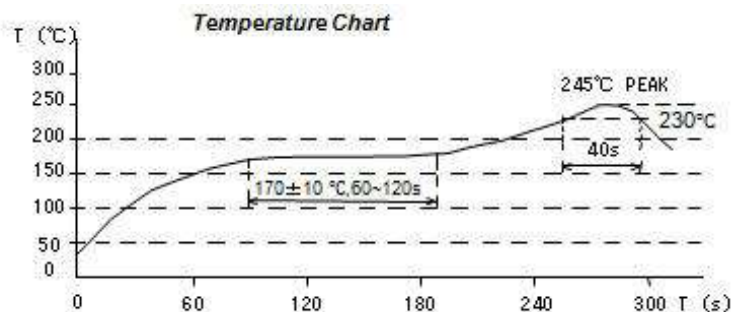
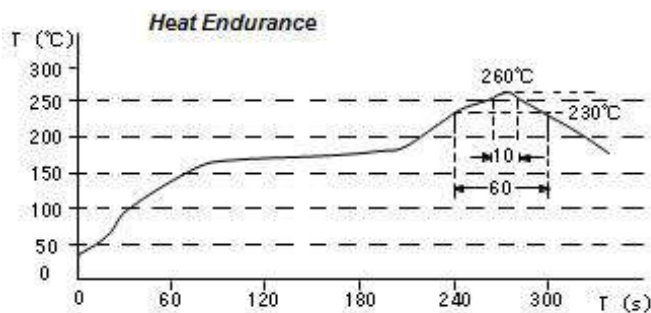

SMD Power Inductor

CD3012MB/DS



直流重畳電流・温度上昇電流グラフ

— L (20°C) — ΔT

1. CD3012MBDS-1R0NC

L (μH) $\Delta T(^{\circ}\text{C})$

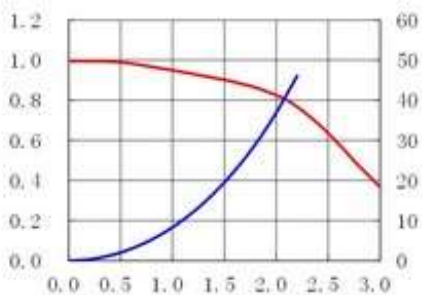

DC(A)

2. CD3012MBDS-1R5NC

L (μH) $\Delta T(^{\circ}\text{C})$

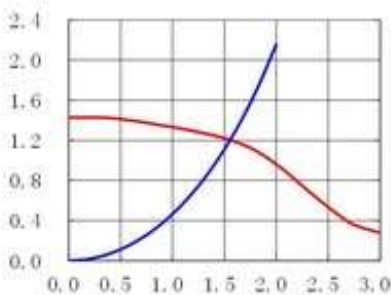

DC(A)

3. CD3012MBDS-2R2PC

L (μH) $\Delta T(^{\circ}\text{C})$

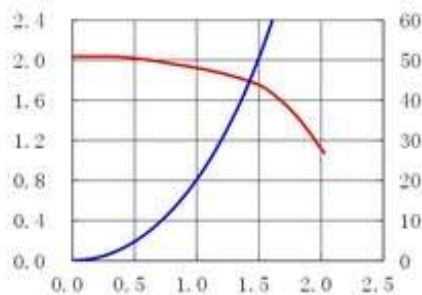

DC(A)

4. CD3012MBDS-3R3PC

L (μH) $\Delta T(^{\circ}\text{C})$

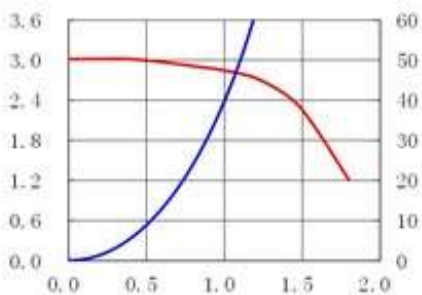

DC(A)

5. CD3012MBDS-4R7PC

L (μH) $\Delta T(^{\circ}\text{C})$

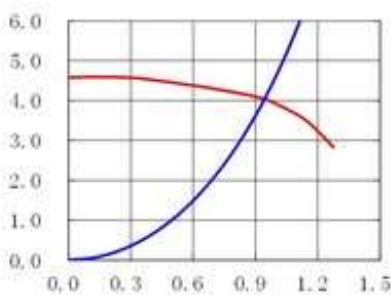

DC(A)

6. CD3012MBDS-6R8PC

L (μH) $\Delta T(^{\circ}\text{C})$

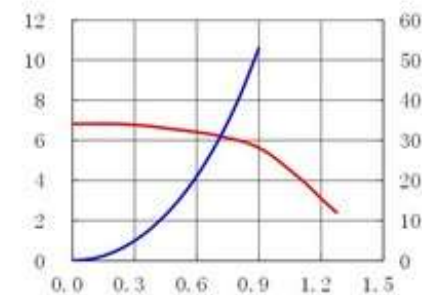

DC(A)

7. CD3012MBDS-100MC

L (μH) $\Delta T(^{\circ}\text{C})$

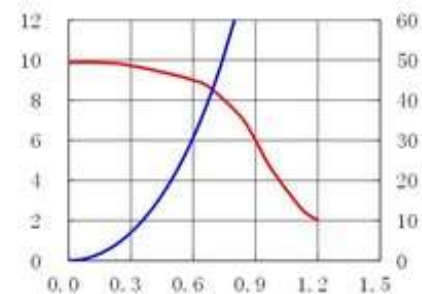

DC(A)

備考: 本仕様書は、製品の改善等により記載内容を予告なく変更することがありますのでご了承ください。また、ご注文の際のお問い合わせは、最寄りの地域営業へご連絡ください。

SMD Power Inductor

CD3012MB/DS



営業所情報のために、当社のウェブサイトを訪問する [ここをクリック](#) してください。